

Motorcycle Batteries



intAct Bike-Power GEL

Sealed maintenance-free GEL battery | electrolyte immobilized by gel-additive | wet charged



FOR HEAVY LOADS, INCLUDING ABS

Delivers 30% more starting power for modern motorcycles with many electrical consumers and covers consumption peaks. Low self-discharge, bike starts reliably even after up to 3 months. Our recommendation if many consumers are installed or the motorcycle is rarely used.

- » **Even more cycle-resistant** than Bike-Power AGM and Bike-Power SLA of the same box size.
- » **Low self-discharge.** For seasonal use.
- » **Very high vibration-resistance.** Electrolyte immobilized by gel-additive.
- » **30% more starting power** than a conventional battery of the same box size. For motorcycles with many consumers, including ABS.
- » **Sealed maintenance-free** battery. Refilling is neither possible nor necessary.
- » Wet charged. **Ready to use.**

Datasheet



Artnum.

IG YT12B-4

Japan-Code

CT12B-4, GT12B-4

Volt

12V

Capacity

10 AH (c20)

CCR - 18°C (EN)

210 A (EN)

Electrolyte

diluted sulphuric acid

Electrolyte density

1,28 +/- 0,01 kg/l (25°)

Size (LxWxH)

150 x 69 x 130 mm

Weight

3,8 kg

Pos. of Terminal

1

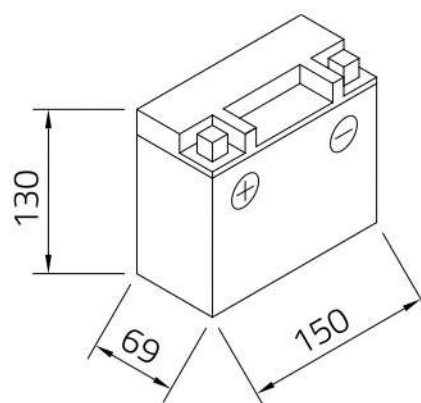
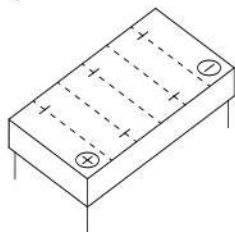

Technology

Sealed maintenance-free GEL battery | electrolyte immobilized by gel-additive | wet charged

Terminal

J

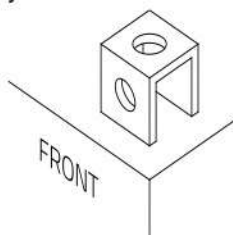

Base plate

-